

GLMX Series GLMX720C 720W LED Grow Light

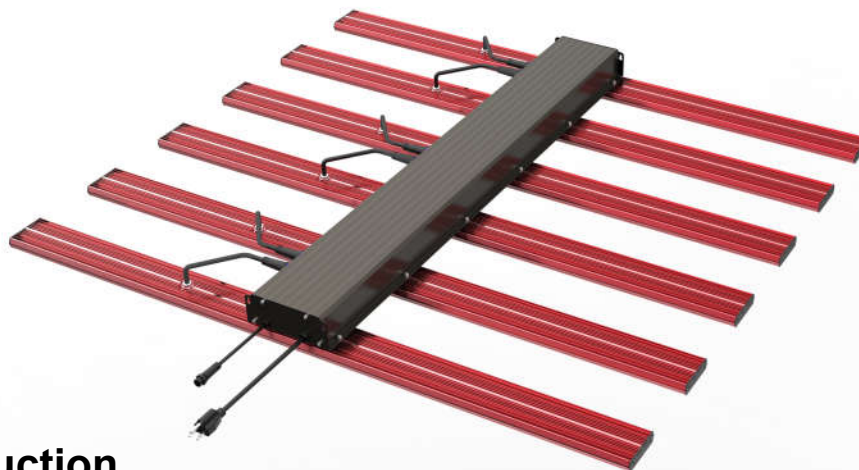

1 Introduction

Thank you for purchasing the GLMX720C. The GLMX720C is a 720W horticultural LED light. It drives six LED bars each of which is 120W. The GLMX720C is intended to be used in indoor grow rooms.

Other types of plug are also available, please check with our sales engineers directly.

This manual describes the installation and connection of the product and also describes how to use the product. Mounting and installing of the GLMX720C may only be executed by certified service personnel. Please read and understand this manual completely before using the product. Only use the product as specified in this manual.

2 Product Information & Specifications

2.1 General Information

Product Name	GLMX720C 720W LED Grow Light			
Manufacturer	Shenzhen VANQ Technology Co., Ltd.			
Version	US	EU	UK	AUS
Plug Type	US plug 120-277V	EU plug 230V	UK plug 240V	AUS/NZS plug 240V
Input Voltage	120-277VAC	100-230VAC	100-240VAC	100-240VAC

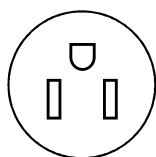

US 5-15P

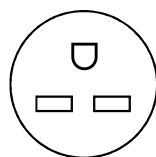

US 6-15P

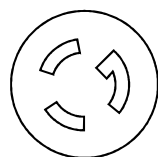

US L7-15P

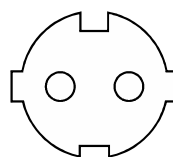

EU plug 230V

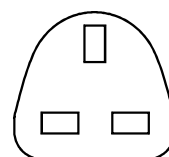



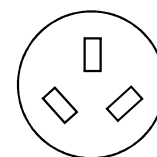









UK plug 240V



AUS/NZS
plug 240V

! Note: Other types of plug are also available, please check with our sales engineers directly.

2.2 Specifications

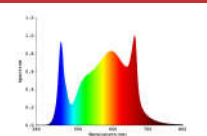
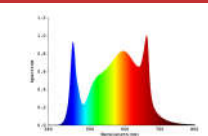
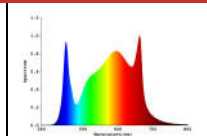
		GLMX 720C-E	GLMX720C-S	GLMX720C-P
Power				
InputPower		720W ±5%	720W ±5%	720W ±5%
InputVoltage(Standard)		100-277VAC	100-277VAC	100-277VAC
HighInputVoltage(Optional)		277-480VAC	277-480VAC	277-480VAC
Light Source Details				
LED Diodes - White	Model	 SMD2835	 SMD2835	 SMD3030
	Supplier	 SAMSUNG	 OSRAM	 SAMSUNG
	Rated Max Power per LED Diode	0.82W ±5% (250mA x 3.3V)	0.82W ±5% (250mA x 3.3V)	0.58W ±5% (200mA x 2.9V)
	Actual Working Power per LED Diode	0.2W ±5%	0.2W ±5%	0.2W ±5%
	LED Diodes Qty Per GLMX720 Series LED Fixture	2880pcs	2880pcs	2880pcs
LED Diodes - Single Color	Model	 RED SMD3030	 RED SMD3030	 RED SMD3030
	Supplier	 OSRAM	 OSRAM	 OSRAM
	Rated Max Power per LED Diode	3W ±5% (1000mA x 3V)	3W ±5% (1000mA x 3V)	3W ±5% (1000mA x 3V)
	Actual Working Power per LED Diode	1W ±5%	1W ±5%	1W ±5%
	LED Diodes Qty Per GLMX720 Series LED Fixture	72pcs	72pcs	72pcs
Total LED Diodes Number		2952pcs	2952pcs	2952pcs
Rated Max Power of all LED Diodes per LED Fixture (NOT ACTUAL POWER OF LED FIXTURE)		2577W ±5%	2577W ±5%	2577W ±5%
Actual Working Power per LED Fixture / Rated Max Power of all LED Diodes per LED Fixture		28%	28%	38%
Spectrum				
Relative Radiation Intensity				
PAR (Photosynthetically Active Radiation)				
PPF(Photosynthetic Photon Flux)	1940 μmol/s	1980 μmol/s	2050 μmol/s	
Efficacy (100%-50% power)	2.7-2.8 μmol/J	2.75-2.9 μmol/J	2.85-3.0 μmol/J	
Recommended Applications				
Indoor Vertical Farming	●	●	●	
Recommended Growing Area (Indoor Vertical Farming)	4ft x 4ft, 1.2m x 1.2m	4ft x 4ft, 1.2m x 1.2m	4ft x 4ft, 1.2m x 1.2m	
Recommended Hanging Height From Canopy (Indoor Vertical Farming)	0.5-1.5ft, 15cm-45cm	0.5-1.5ft, 15cm-45cm	0.5-1.5ft, 15cm-45cm	
Indoor Horizontal Farming	▶	▶	▶	
Recommended Growing Area (Indoor Horizontal Farming)	4.5ft x 4.5ft 1.35m x 1.35m	4.5ft x 4.5ft 1.35m x 1.35m	4.5ft x 4.5ft 1.35m x 1.35m	
Recommended Hanging Height From Canopy (Indoor Horizontal Farming)	1.5ft-2ft, 45cm-60cm	1.5ft-2ft, 45cm-60cm	1.5ft-2ft, 45cm-60cm	
Physical				
LED Fixture Weight	13kg, 28.6 lbs			
Dimensions	111cm L x 97.5cm W x 7.5cm H, 43.7in L x 38.38in W x 2.95in H			
Working Temperature	-20°C ~ 40°C -4°F ~ 104°F			
Dimming	0-10V			
Waterproof	Yes			

2.3 Technical specifications

Light Source	LED
AC Input Power	720W @ 240VAC
AC Input Voltage	120-277V AC, 347-480V AC, 50/60Hz
Spectrum	Full Spectrum
Light Output PPF	1940 $\mu\text{mol/s}$ (VQ-GLMX720C-E)
Efficiency	2.7 $\mu\text{mol/J}$ (VQ-GLMX720C-E)
Product weight	13 kg
Dimensions	111cm L x 97.5cm W x 7.5cm H, 43.7in L x 38.38in W x 2.95in H
Working temperature	-20° C ~ 40° C -4° F ~ 104° F
Light Distribution	120°
Dimming	0-10V
Waterproof	Yes

ORDERING CODE MATRIX FOR GLMX720C LIGHT FIXTURE

ORDERING CODE MATRIX FOR LIGHT FIXTURE				
FAMILY	MODEL	INPUT VOLTAGE	LED	PLUG TYPE
GLMX	720C	S 100-277VAC	SO	US5 NEMA 5-15P
		P-S 277-480VAC	Samsung281B+OSRAM	US6 NEMA 6-15P
			OO	USL7 NEMA L7-15P
		* P-S is only available with pigtail power cord	OSRAM+OSRAM	EU EU 230V
			BO	UK UK 240V
			Samsung301B+OSRAM	AUS AUS/NZS 240V
				P Pigtail

NOMINAL ELECTRICAL AC INPUT

AC Voltage	120V	208V	230V	277V	347V	380V	400V	480V
AC Current	6.05A	3.47A	3.12A	2.58A	2.07A	1.9A	1.81A	1.50
AC Power	726W	723W	719W	716W	721W	725W	726W	722W
Power Factor	0.98	0.98	0.98	0.98	0.98	0.98	0.97	0.97

- ⚠ **Note:** The standard model comes with LED driver supporting only 100-277VAC input. 347V, 380V, 400V, 480V needs to be specially customized, please check with our sales engineers directly.

2.4 Compatible products and accessories

Product	Product Name	Part Number
Controller	0-10V dimming controller	VQ-VD100
Power cord	Power cord with US plug 5-15P, 1.5m/5ft	VQ-PC-US515
	Power cord with US plug 6-15P, 1.5m/5ft	VQ-PC-US615
	Power cord with US plug L7-15P, 1.5m/5ft	VQ-PC-USL715
	Power cord with EU plug 230V, 1.5m/5ft	VQ-PC-EU230
	Power cord with UK plug 240V, 1.5m/5ft	VQ-PC-UK240
	Power cord with AUS/NZS plug 240V, 1.5m/5ft	VQ-PC-AU240
Dimming cables	T-shape daisy chain connection dimming cable, 2m/6.5ft	VQ-DCC-T01
Light Hanger	1/8" Adjustable Ratchet Hangers 1.8m/6ft (Set of 2 - Holds 150 lbs/100Kg)	VQ-RH-01
	Steel Wire Rope Hanger 30cm/1ft (Set of 4 - Holds 150 lbs/100Kg)	VQ-WR-01

2.5 Environment

The product is intended to be used in indoor growing environments. The product can be used in wet environments.

The product may not be used outdoors. The GLMX720C light functions optimal when the max ambient temperature is between 20~40° C.

3 Packing List

Please follow the content of the list and carefully check whether the purchased equipment and accessories are complete. If you find that the actual product does not match the list, or the product is damaged, please contact us immediately and provide photos or videos!



1. Driver Box X 1



2. LED Bar X 6

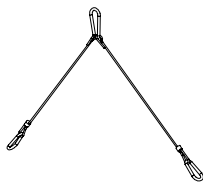

3. Steel Wire
Rope Hanger X 2



4. 1/8" Adjustable
Ratchet Hangers X 2



5. Connection
Screws X 12

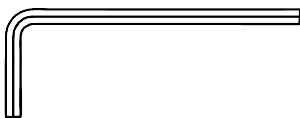

6. Hex key X 1

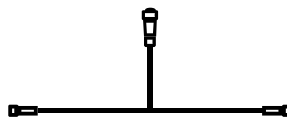

7. Dimming Cable
(optional) X 1



8. VD-100 Controller
(optional, buy
separately) X 1

No.	Product Name	Model	Quantity
1	Driver Box	720W	1
2	LED Bar	120W	6
3	Steel Wire Rope Hanger	30cm/1ft	2
4	1/8" Adjustable Ratchet Hangers	1.8m	2
5	Screws	SUS304 M4-8	12
6	Dimming Cable(optional)	T-Shape	1
7	VD-100 Controller(optional, buy separately)	0-10V Dimming	1
8	Hex key	M3	1

4 Safety Precautions & Warnings

Warning!

Carefully read the warnings below before using or working with the product!

- ⚠ Always adhere to the local rules and regulations when installing or using the LED light.
- ⚠ DO NOT connect to live power until installation is complete.
- ⚠ Do not open or disassemble the LED light. Opening or modifying the LED light can be dangerous and will void the warranty.
- ⚠ Do not use the LED light when either the LED light or its power cord are damaged. Replace the power cord only with original certified cords.
- ⚠ Modifications to the cords can lead to unwanted electromagnetic effects, which makes the product not comply with legal requirements.
- ⚠ Do not expose the LED light to:
 - (ambient) temperatures outside the specified range;
 - dust and contamination;
 - direct sunlight during use or HID light that could heat up the ballast.
- ⚠ Always disconnect the LED light from mains before performing any maintenance.
- ⚠ Always allow for a cool down period of at least 30 minutes before touching the LED bars. Touching the LED bars when the light is lit or immediately afterwards can result in severe burns!
- ⚠ Do not use the LED light near flammable, explosive or reactive substances. Do not use sulfur vaporizers or water misters.
- ⚠ The installation and use of the LED light is the responsibility of the end user. Incorrect use or installation can lead to failure and damage to the LED light. Damage to the LED light and electronic circuitry as a result of incorrect installation and use revokes the warranty.

5 Installation

Warning!

- ⚠ Mounting and installing of the LED light may only be executed by certified service personnel, in accordance with the applicable local laws and regulations.
- ⚠ The installer is responsible for correct and safe installation.
- ⚠ Ensure the local cabling can support the voltage and current requirements of the LED light.
- ⚠ Avoid coiled cords and keep mains leads separated. This prevents electromagnetic interference.
- ⚠ Do not connect or disconnect the LED light under load.
- ⚠ Mount the system to something that can hold the weight of the LED light.

5.1 Fixing the LED bars to driver box

- Fixing the LED bars(No.2) to the Driver Box(No.1) with the Screws(No.5)

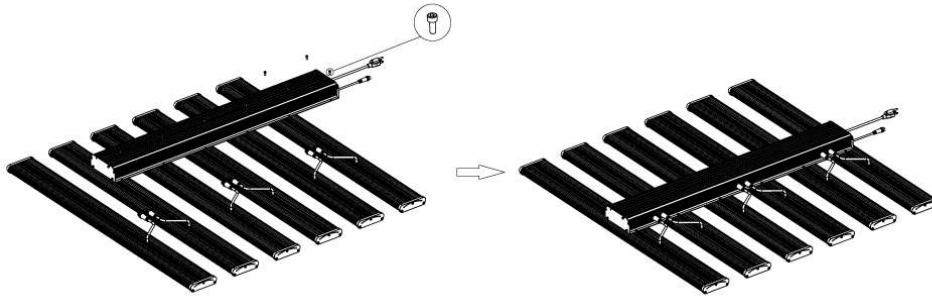

- Connecting the power cables of LED bars and Driver box

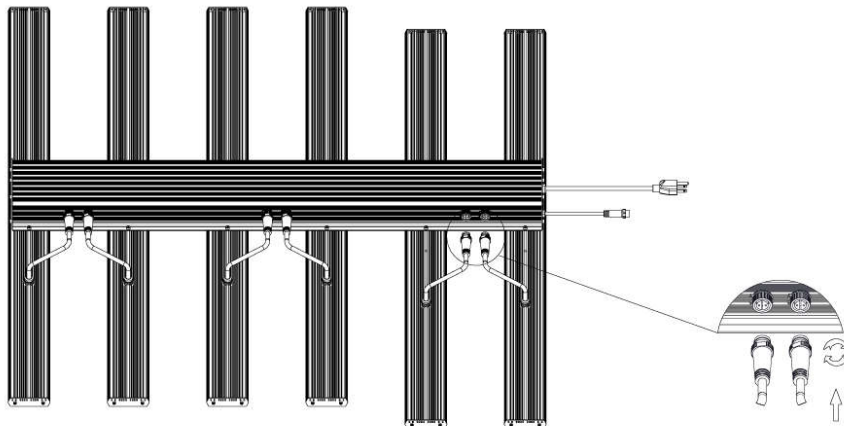

5.2 Hanging the LED light to mounting system

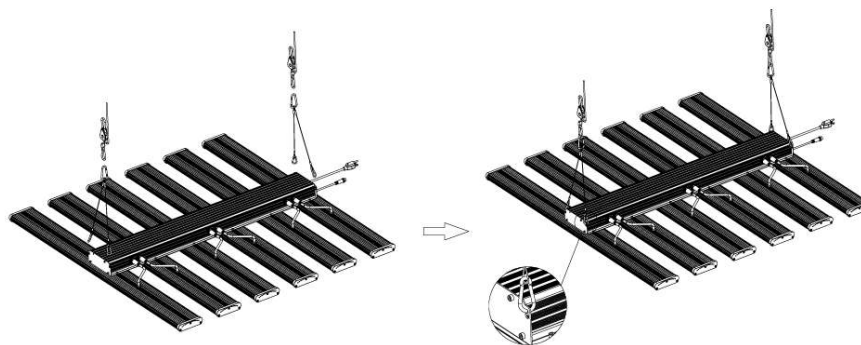

The suggested height from the plant canopy to the LED light is:

During vegetative stage, 1ft - 1.5ft/30cm - 45cm

During flowering stage, 0.6ft - 1ft/15cm - 30cm

Below is the PPF map of 5ft x 5ft/1.5m x 1.5m at 3 different hanging heights.

*Typical data of GLMX720C tested in a 5ftx5ft grow tent

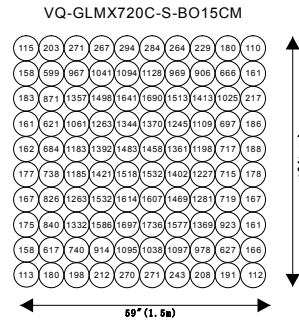
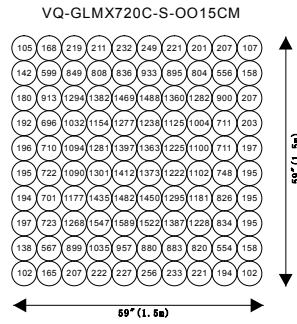
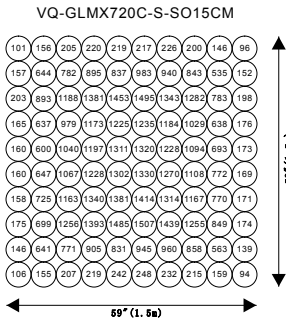

• PPFD map at 0.5ft/15cm

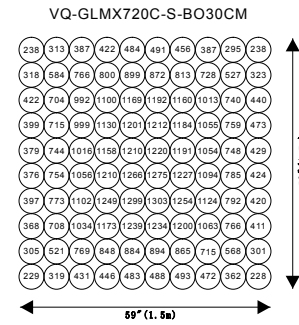
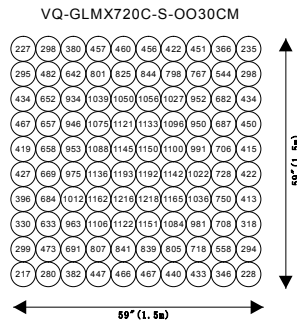
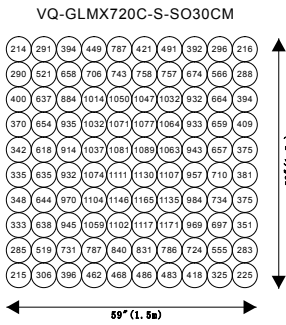

• PPFD map at 1ft/30cm

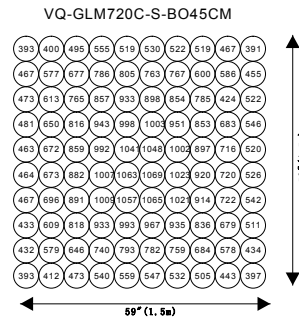
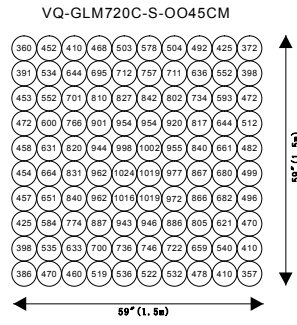
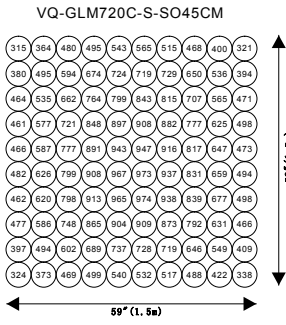

• PPFD map at 1.5ft/45cm

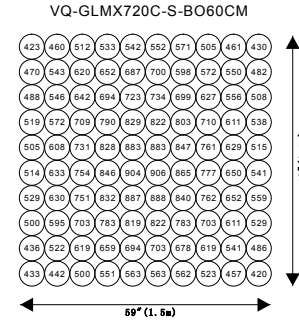
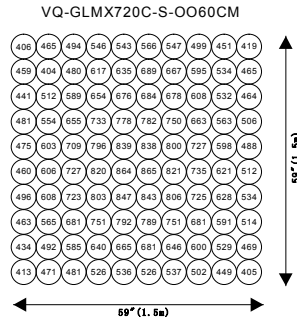
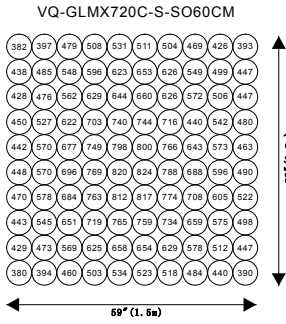

• PPFD map at 2ft/60cm

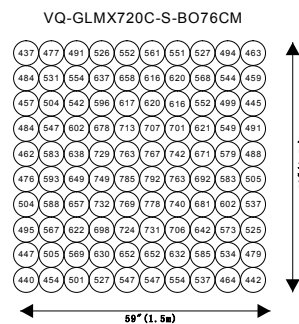
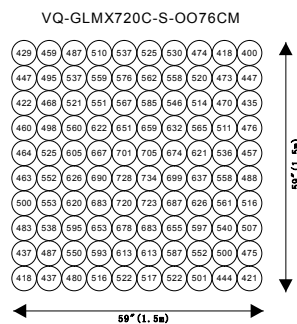
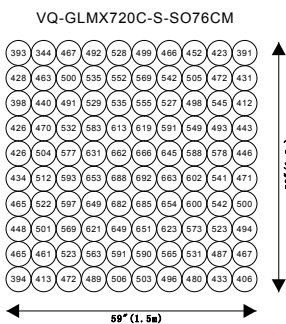

• PPFD map at 2.5ft/76cm

5.3 Connecting the LED light to the mains

Warning!

- ⚠ Make sure mains power is switched off.
- ⚠ Ensure the cord is not coiled and does not touch any hot surfaces.
- ⚠ Connect the cables according to local rules, safety regulations and electrical code.
- ⚠ Ensure external switching gear can cope with the inrush current of the LED fixture. Always use a double pole contactor suitable for switching a capacitive load. Never use household timers to switch the LED fixture!

6 Connecting LED Lights To A Controller

Warning!

- ⚠ Do not connect or disconnect the controller with LED light under load.
- ⚠ Ensure the power cord and the controller cables do not touch any of the LED bars.

Using a daisy chain setup, a maximum of 50pcs LED lights can be connected to one controller. The controller can dim the LED light from 0 to 100%.

- Connect the dimming cable to the dimming port on the first LED light.
- Use dimming cable (T-shape) to connect the dimming port of the following LED light.
- Repeat these steps to connect up to 50pcs LED lights.

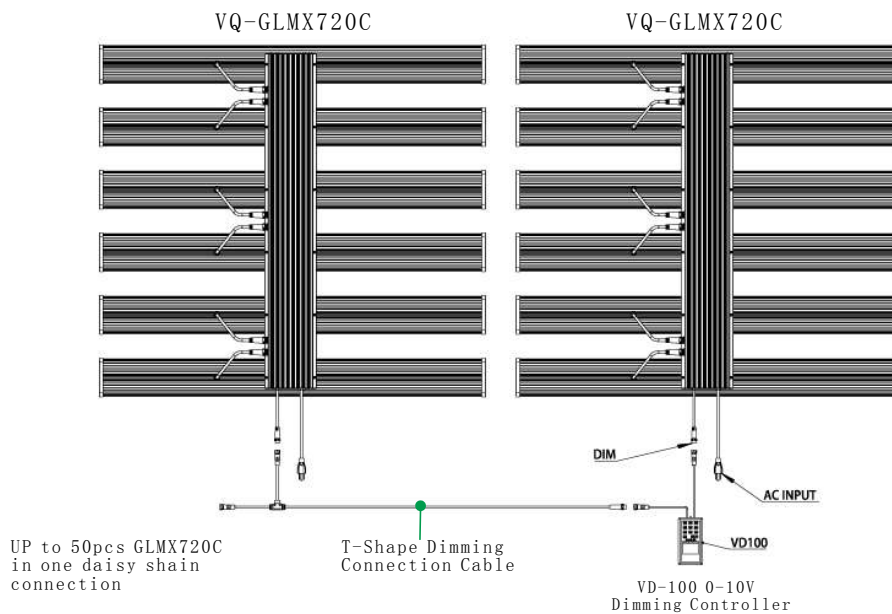

7 Size & Packaging:

7.1 Size

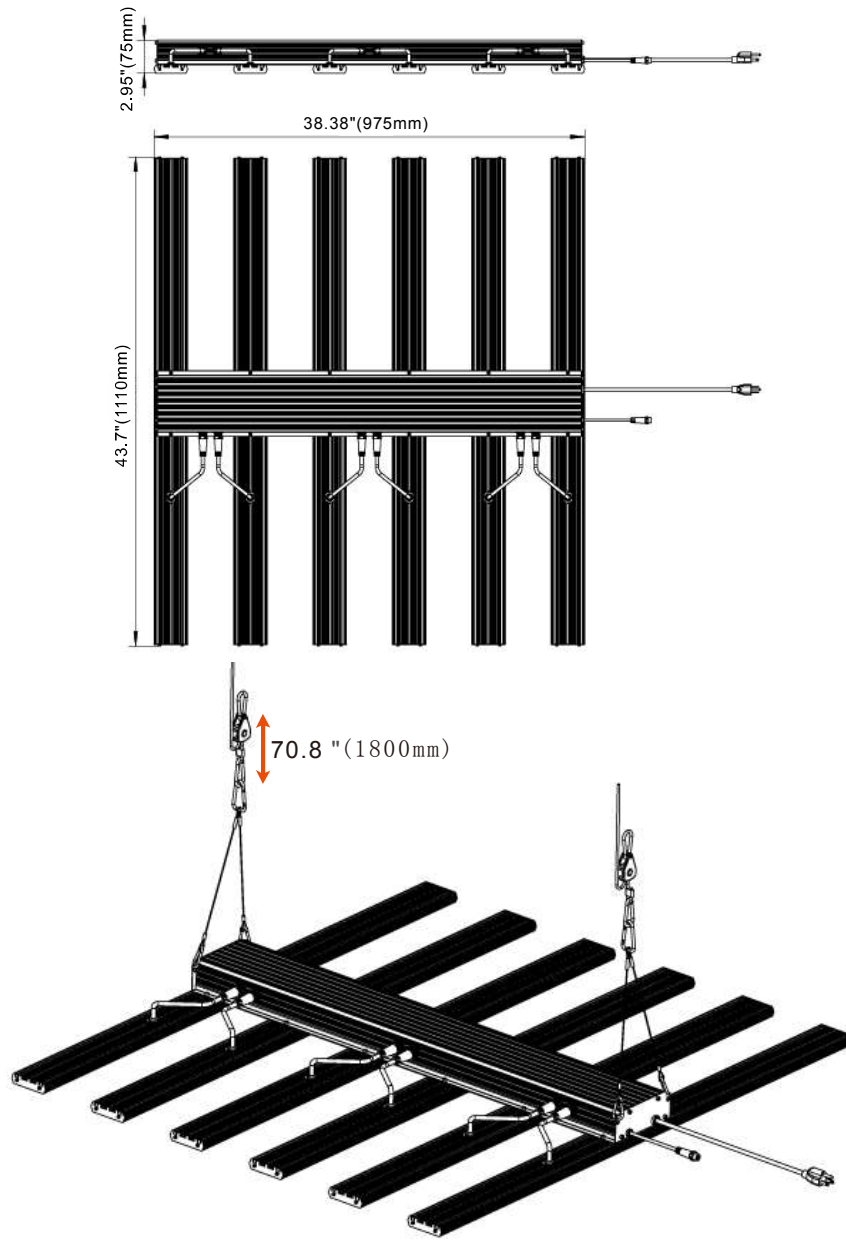

7.2 Packaging:

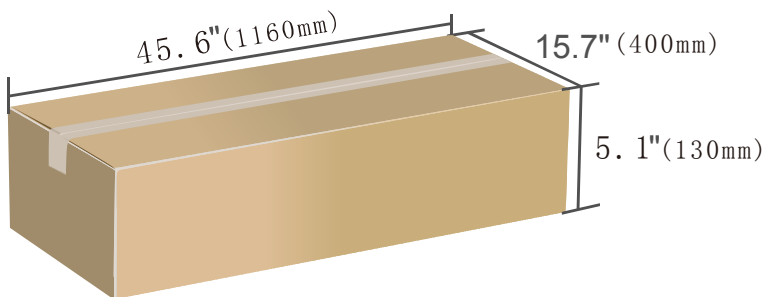

Net Weight: 35.31b (16 kg)

Packaging:
1pcs/carton

Gross Weight:
16kg 35.3lbs

Size:
45.6in L x 15.7in W x 5.1in H
1160mm L x 400mm W x 130mm H

Packaging material
plastic+foam+carton

8 Inspection, maintenance and repair

- ⚠ Caution! Do not clean the LED fixture with detergents, abrasives or other aggress
- Regularly check the LED fixture for dust or dirt buildup. Clean if necessary. Contamination may cause overheating and decreased performance. Clean the outside of the LED fixture using a dry or damp cloth.
- Regularly check the cables of the LED fixture to ensure it is undamaged.

9 Storage and disposal

- Store the LED fixture in a dry and clean environment, with an ambient temperature of 20~85° C.
- The product must not be discarded as unsorted municipal waste, but must be collected separately for the purpose of treatment, recovery and environmentally sound disposal.

10 Warranty service

VANQ technology warrants the mechanical and electronic components of their product to be free of defects in material and workmanship if used under normal operating conditions for a period of five (5) years from the original date of purchase. If the product shows any defects within this period and that defect is not due to user error or improper use, VANQ technology shall, at its discretion, either replace or repair the product using suitable new or reconditioned products or parts. In case VANQ technology decides to replace the entire product, this limited warranty shall apply to the replacement product for the remaining initial warranty period, i.e. five (5) years from the date of purchase of the original product. For service, return the GLMX720C light to your shop with the original sales receipt.