



## GLTW050 50W LED

### Grow Light Bar

#### Table of Contents

Specifications.....	2
Spectra.....	3
PPFD Chart.....	5-7
Installation.....	8
Packaging.....	9

#### Features

---

GLTW050 is the ideal LED grow light for professional growers using vertical farming growing methods.

- Customizable spectrum for various growing applications.
- High PPF and Efficacy: 135  $\mu\text{mol/s}$ , 2.7  $\mu\text{mol/J}$
- Unique rectangular light distribution, and superior thermal conductivity
- Industrial grade IP65 waterproof protection
- Daisy Chain Functions.

#### Applications

---

- Indoor Plant Growing
- Cannabis Cloning

## Specifications

### GLTW050

Power Consumption (max)	50W±5%
Dimensions	47.2in L x 1.65in W x 2.6in D 1198mm L x 42mm W x 67mm D
Weight	1.3 kg   2.87 lbs
Typical PPF	135 μmol/s(spectrum dependent)
Efficacy	2.7 μmol/J(spectrum dependent)
Input Voltage\Frequency	AC100~240V/47~63Hz
Spectrum	FSV,FST
Power Factor	220V≥0.95   110V≥0.98
Cooling	Passive
Structure Material	Aluminum
Working Temperature	-20°C ~ 40°C   -4°F ~ 104°F
Light Distribution	80°
Daisy Chain(Max)	10pcs
Lifetime	L90≥50,000 hrs
IP Rating	IP65
Warranty	2 years standard

## Dimensions

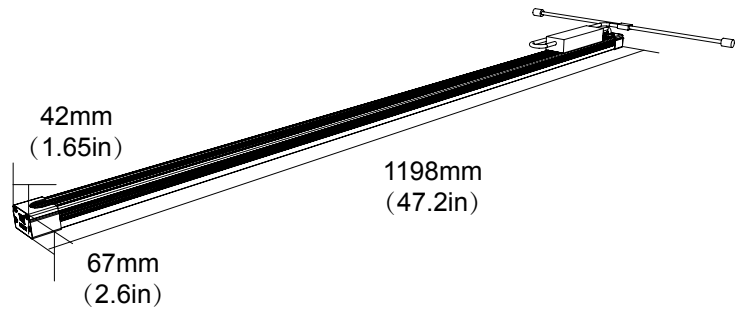

1198mm L x 42mm W x 67mm H  
47.2in L x 1.65in W x 2.6in H

## Daisy Chain

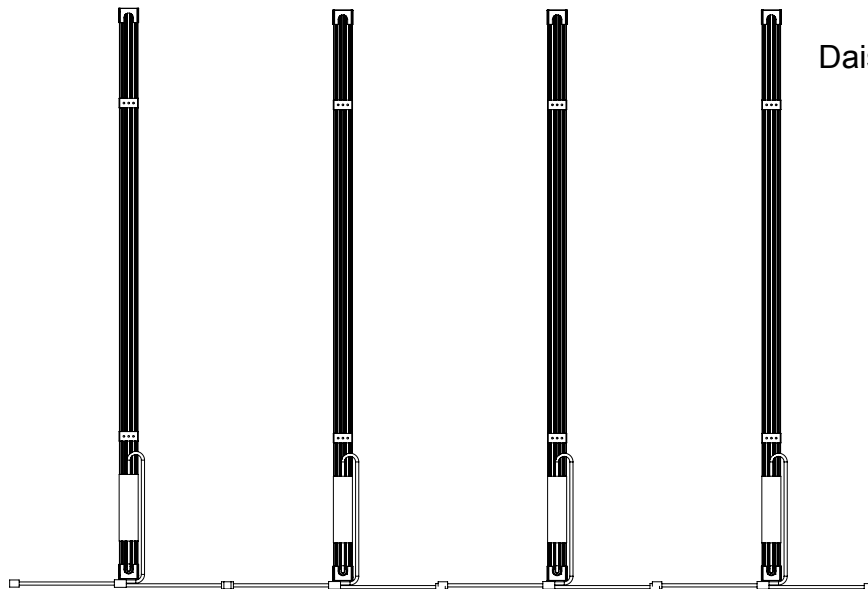

Daisy Chain Function

Up to 10pcs GLTW050 fixtures can be powered in a daisy chain connection way.

## Spectrum

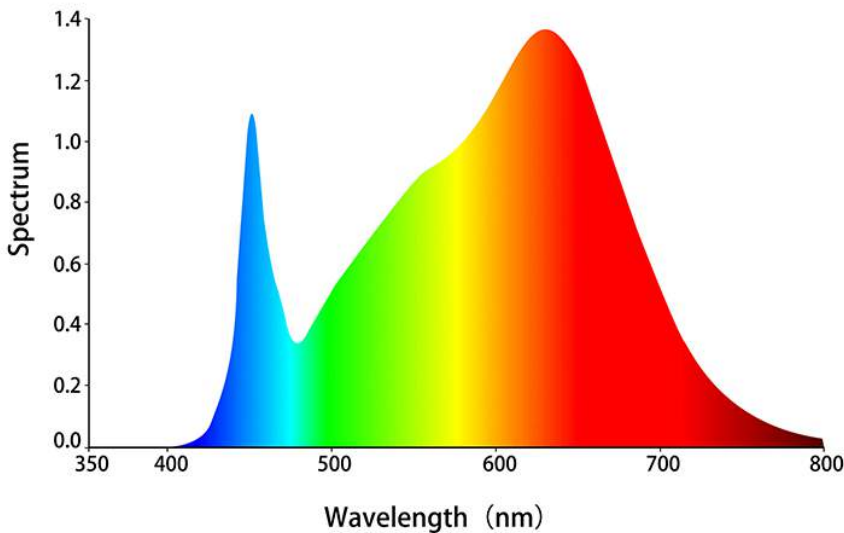

**VC3**

### Tailor-made Spectrum For Leafy Greens

With a broad full spectrum of warm white, this VC3 spectrum focuses on vegetative growth phases and propagation. The recipe delivers shorter, compact plants with a good biomass ratio – the high energy in the blue 450nm bandwidth also promotes stomata opening. All together a good balance between both photon levels guarantees a good mix between vegetative growth and biomass production.

Custom spectrum is also available according to specific plant species.

### Tailor-made Spectrum For Cannabis Cloning

The CN3 spectrum is tailor-made with cool white LEDs with a continuous spectral emission across PAR 400 -700nm wavelength range. This heavy blue spectrum is essential for stimulating healthy root growth and improving root extension, while the overall balancing spectral output also ensures the healthy growth of leaves and stems.

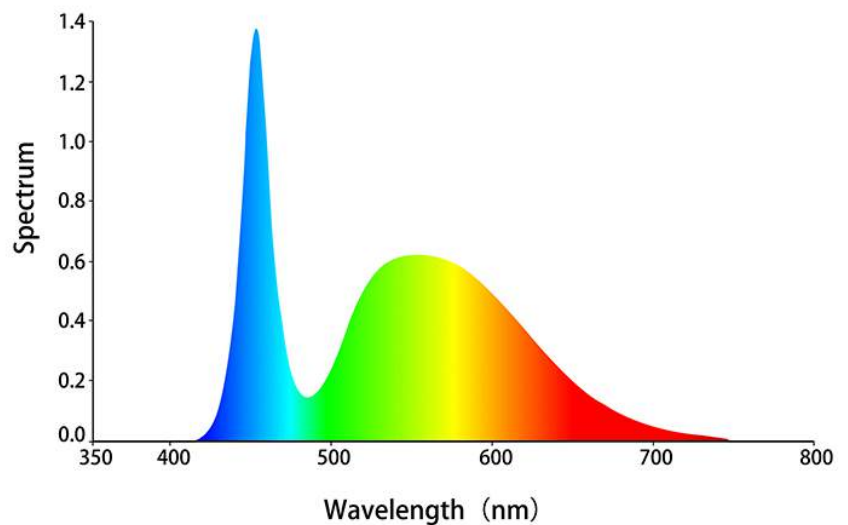

**CN3**

## Rectangular Lighting Footprint

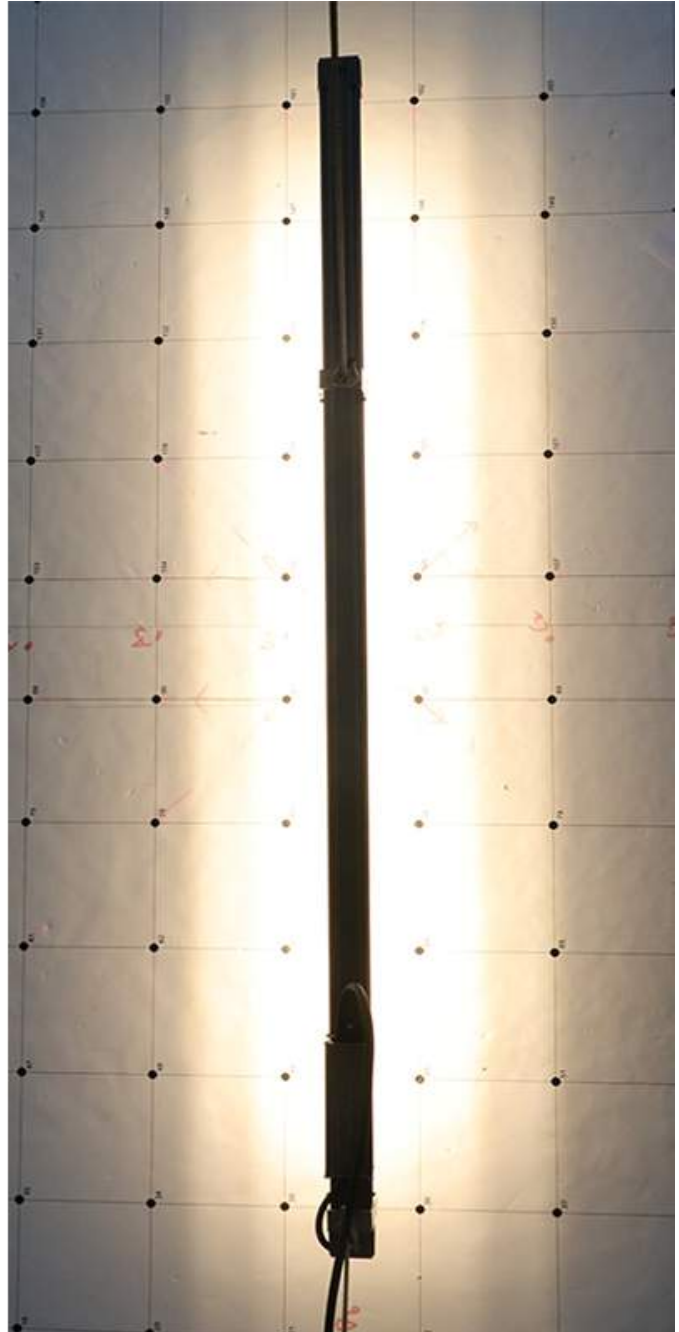
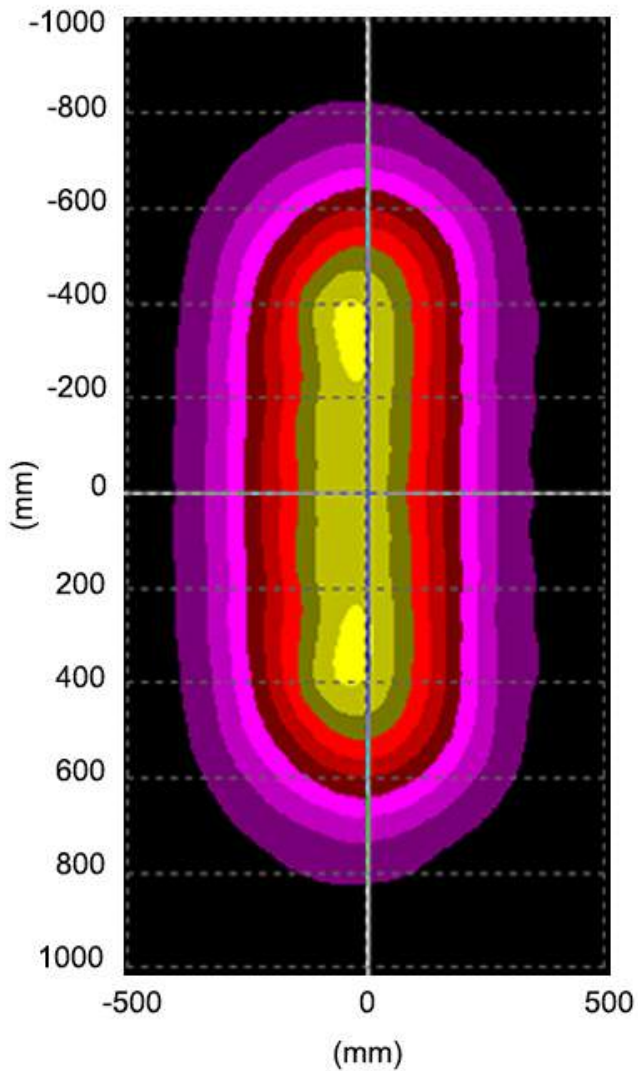

The unique optical design of GLTW050 delivers an approximately rectangular lighting footprint. Light utilization is above 95% within the 2ft(0.6m) x 4ft(1.2m) rectangular footprint at hanging height of 12in(30cm).

## PPFD Chart of **Single GLTW050 LED Bar**



**PPFD Map of GLTW050 at 30cm(hanging height)**  
**Test Footprint: 50cm x 120cm**

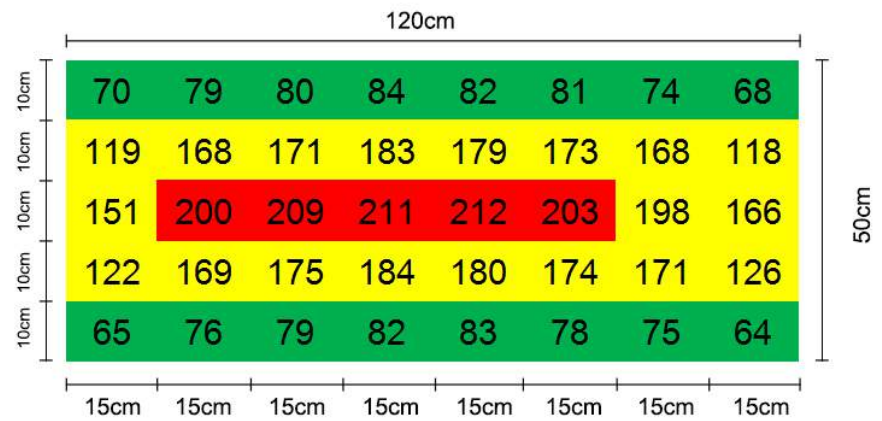

**PPFD Map of GLTW050 at 40cm(hanging height)**  
**Test Footprint: 75cm x 120cm**

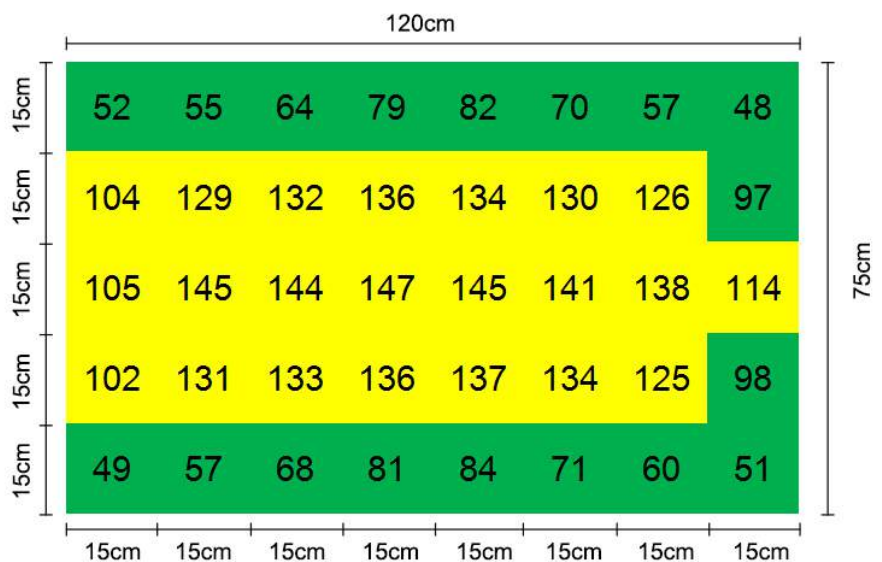

## PPFD Chart of 4 GLTW050 LED Bars

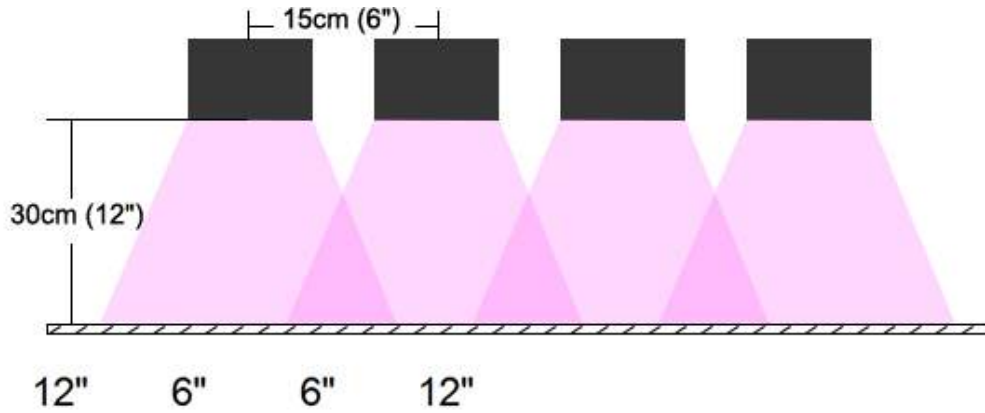

24"	227	355	361	233
18"	293	390	396	280
12"	280	391	398	276
6"	287	384	391	293
6"	309	393	400	287
12"	289	381	388	282
18"	273	384	391	291
24"	238	336	342	238

Hanging Height:  
30cm(12")  
LED Bars Spacing:  
15cm(6")  
LED Bars Qty:4pcs

Avg. PPFD:327  $\mu\text{mol}/\text{m}^2/\text{s}$

## PPFD Chart of 3 GLTW050 LED Bars

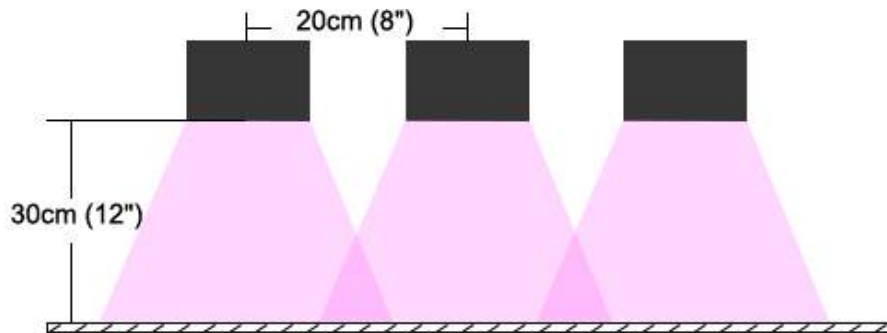

Avg. PPFD: 251  $\mu\text{mol}/\text{m}^2/\text{s}$

## PPFD Chart of 2 GLTW050 LED Bars

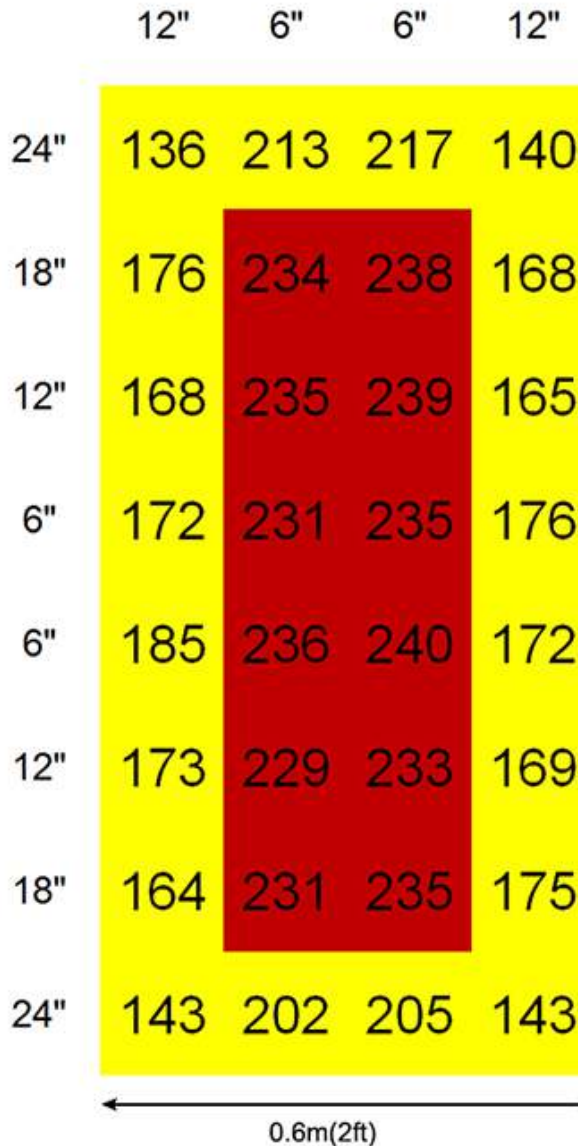
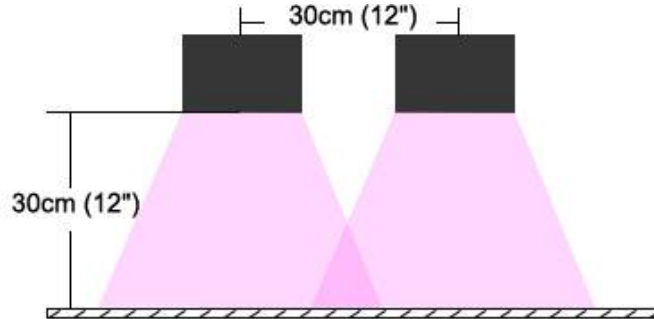

Hanging Height:  
30cm(12")  
LED Bars Spacing:  
30cm(12")  
LED Bars Qty:2pcs

Avg. PPFD:196  $\mu\text{mol}/\text{m}^2/\text{s}$



## Installation

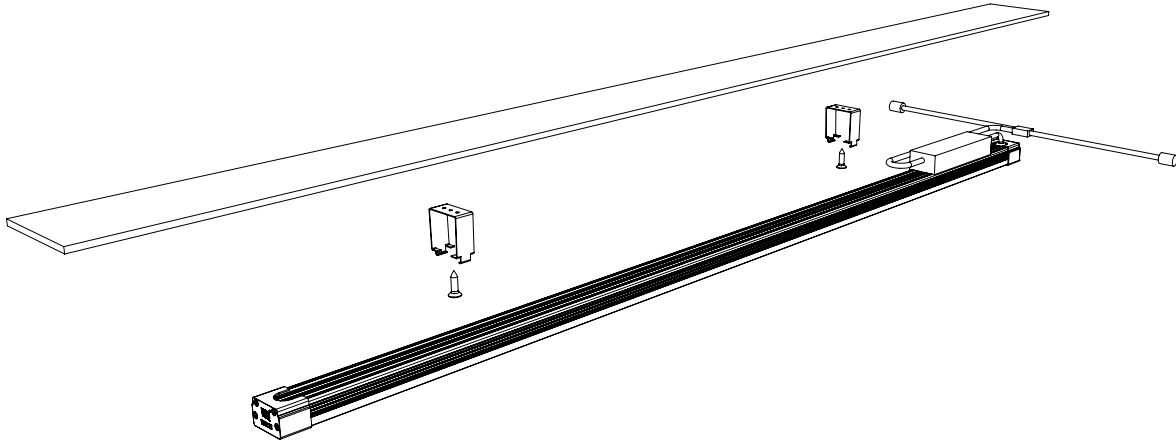

## Mounting

## Packing List



## GLTW050 x 12



Mounting bracket x 24

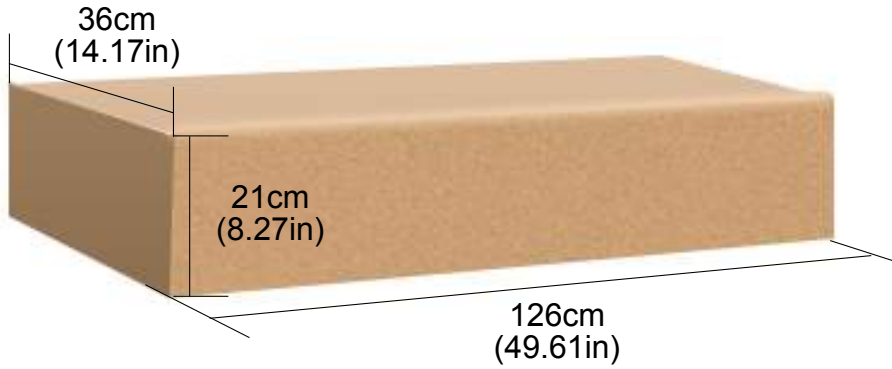

Screw x 24

**Packaging****Packaging:**

12 pcs/carton

**Gross Weight:**

18 kg | 39.68 lbs

**Size:**

49.61in L x 14.17in W x 8.27in D  
126cm L x 36cm W x 21cm D

**Packaging Material:**

Plastic + Foam + Carton

# Warranty Policy

## 1. Warranty period

VANQ GLTW Series light fixtures have a standard TWO-year limited warranty. Warranty period starts from the date of receiving products.

This warranty policy does NOT apply to any customized product based on our standard GLTW Series models. The warranty policy of customized products is subject to the contract of the order.

## 2. Limited Warranty

The warranty as described herein shall only apply to VANQ branded lighting products sold by VANQ and the authorized agents. The warranty is only applicable to the party purchasing the products directly from VANQ and the authorized agents. VANQ warrants that each Product will be free from defects in material and workmanship. If a product fails to operate in accordance with this warranty VANQ will provide free replacement of the failed Product subject to the applicable warranty policy and the limited warranty terms and conditions as below.

## 3. Terms and Conditions

- If any Product covered by this warranty is returned by Purchaser in accordance with the warranty policy and upon examination, VANQ determines to its satisfaction that such Product failed to satisfy this warranty, VANQ will, at its option, repair or replace the Product or the defective part thereof. For purposes of clarity, "repair or replace the Product or the defective part thereof" does not include any removal or reinstallation activities, costs or expenses, including without limitation labor costs or expenses.
- If VANQ chooses to replace the Product and is not able to do so because it has been discontinued or is not available, VANQ may replace the product with a comparable product (that can show small deviations in design and product specification).
- No agent, distributor or dealer is authorized to change, modify or extend the terms of the limited warranty on behalf of VANQ in any matter.
- This limited warranty only applies when the Product has been properly wired and installed and operated within the electrical values, operating range and environmental conditions provided in the specifications, application guidelines, or any other document accompanying the Products. If a Product is found to be defective, or not performing per the product specifications, the Purchaser must notify VANQ in writing.
- VANQ will facilitate the technical resolution of problems. Third-party products sold by VANQ are not covered under this warranty, except as indicated specifically in agreement.
- This warranty does not apply to damage or failure to perform arising as a result of any Acts of God or from any abuse, misuse, abnormal use or use in violation of any applicable standard, code or instructions for use including without limitation those contained in the latest safety, industry and/or electrical standards for the relevant region(s).
- This warranty shall be void in the event in which any repairs or alterations not duly authorized by VANQ in writing are made to the Product by any person. The manufacturing date of the product has

to be clearly readable. VANQ reserves the right to make the final decision on the validity of any warranty claim.

- If requested by VANQ the non-conforming or defective Products shall become VANQ's property as soon as they have been replaced.

#### **4. Warranty Claims**

All warranty periods mentioned are subjected to VANQ having enough information of the failed product for verification of non-compliance. Guarantee claims have to be reported to VANQ within 30 days after discovery, specifying at least the following information (additional info may be required on request):

- Products failed, for international purchase, pictures and videos are required.
- Installation date and invoice date.
- Detailed problem description and number and % of failures, date-code of failure.
- Application, hours burned and switching cycles.
- VANQ may charge Customer for returned Products that are not found to be defective or non-conforming together with the freight, testing and handling costs associated therewith.

#### **5. Notifications**

- Products have to be applied and used in accordance to products specifications and application guides.
- Compensation for international purchase is product replacement or free parts for all confirmed failures.